

## ETC – ELECTRONIC TEMPERATURE CONTROL INSTALLATION & MAINTENANCE

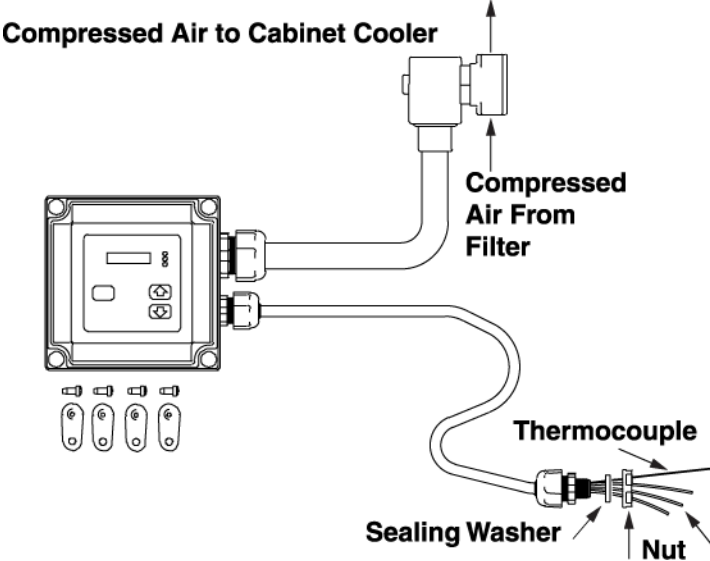

**Compressed Air to Cabinet Cooler**

**Compressed Air From Filter**

**Thermocouple**



**Sealing Washer**

**Nut**

**Power Leads**

<b>Power Supply Voltage:</b>	120 VAC (Model 9238) 240 VAC (Model 9239)
<b>Frequency:</b>	50/60 HZ
<b>Power Supply Current:</b>	165 mA max
<b>Sensor:</b>	Type J Thermocouple
<b>Control Range:</b>	70 - 130°F
<b>Accuracy:</b>	± 1°F of the temperature setting
<b>Enclosure rating:</b>	NEMA 4X, IP 65, UL508 UL94-5V Polycarbonate
<b>Temperature Sampling Rate:</b>	1 Reading/second
<b>Max. Temp.:</b>	158°F (70°C)
<b>Replacement Fuse: Model 9238</b>	Buss AEC 5A 120V Fast Acting
<b>Model 9239</b>	Buss AEC 5A 250V Fast Acting
<b>Replacement Fuse Size:</b>	Ø 1/4" x 1-1/4" (Ø 6.3mmx32mm)

**THE ETC SHOULD NOT BE USED IN AN EXPLOSIVE OR FLAMMABLE AREA.**



EXAIR's ETC (Electronic Temperature Control) provides precise temperature control of the EXAIR Cabinet Cooler System. The LED display is easily viewed from a distance and constantly monitors the internal temperature of the electrical enclosure. The ETC system is designed to meet and comply with NEMA 4, 4X, 12 and IP65 ratings. Temperature can be changed quickly with the touch of a button. The ETC offers the reliability of a solid state temperature controller and uses a quick response Type J thermocouple for temperature measurement.

**ALWAYS DISCONNECT THE POWER PRIOR TO REMOVING THE COVER.**



- Solenoid surface can become hot after prolonged use. Allow to cool completely before touching.

### INSTALLATION

Please refer to the Cabinet Cooler Installation and Maintenance Sheet that is enclosed with the Cabinet Cooler<sup>®</sup>. The ETC has been pre-wired for fast installation. It is easily substituted for EXAIR's standard valve and thermostat kit (as shown on the Cabinet Cooler Installation and Maintenance sheet).

### Pre-Installation requirements to maintain CE compliance

- a) Since the ETC is permanently wired, an external switch or circuit breaker must be added during installation as a disconnection device.
- b) The switch or circuit breaker shall meet the relevant requirements of IEC 60947-1 and IEC 60947-3 and disconnect all current carrying conductors and shall not interrupt the Protective Earth (Ground) Conductor.
- c) For all supply wiring, circuit breakers and switches, a minimum 15A load carrying capacity is required, in addition to meeting all local electric codes.
- d) Switch and circuit breaker must be labeled with "I" symbol for On and "O" for Off.
- e) Since the ETC is permanently wired, grounding per local codes must be maintained.

Since the ETC is intended to be permanently wired, do not position equipment in a space where it is difficult to operate the power disconnect (external switch or circuit breaker). Power disconnect should be near the equipment and within reach of the operator of the ETC unit.

1. Connect the compressed air supply to the solenoid valve, paying attention to flow direction arrow on brass valve body (in and out). The solenoid valve should be located downstream from the filter(s) and before the Cabinet Cooler. For ease of connecting the compressed air pipe to the solenoid valve, the electrical coil can be detached from the valve body by removing the metal clip with a flat blade screwdriver.
2. Locate the desired position for the ETC plastic enclosure. The ETC is lightweight, and is easy to mount. The ETC comes with (4) mounting feet and (4) self tapping screws. To mount the feet to the box, remove the cover and drop one of the self tapping screws into one of the (4) holes on the base of the box where the cover was mounted. Place one of the mounting feet into the corresponding hole on the bottom of the base and tighten the screw. Repeat for other (3) holes. Replace the cover and tighten the screws holding the cover to the base. See Figure at right. The ETC can now be mounted using the 4 holes in the mounting feet. Use #10 or M5 screws.
3. Drill a 1/2" (13mm) diameter hole through your electrical enclosure to locate the electrical supply for the ETC.
4. Remove hex nut from the ETC liquid tight conduit connector.
5. Thread the (3) wires and the thermocouple through the drilled hole. The foam sealing washer should be placed on the outside of your electrical enclosure between the liquid tight conduit connector and the metal enclosure. Tighten the retaining nut from the inside of the enclosure to ensure a tight seal at the foam washer.
6. For 120 VAC, make the following connections:  
Black – Hot  
White – Neutral  
Green/Yellow – Ground

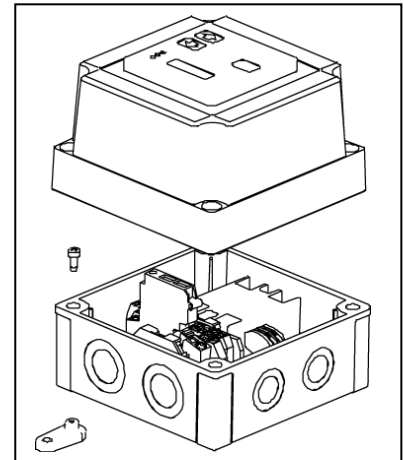

For 240 VAC, make the following connections:

Orange – Hot

Orange – Hot

Green/Yellow – Ground

7. Position the thermocouple inside the enclosure where desired. It is not sensitive to mounting position. The thermocouple must be mounted inside the enclosure. It should not be mounted directly in the cold airstream that exhausts from the Cold Air Distribution Kit. Do not kink the wires. Ordinary tape can be used to hold the thermocouple in position.

**Note:** Protection provided by the equipment may be impaired if the equipment is used with accessories not provided or recommended by the manufacturer, or is used in a manner not specified by the manufacturer. Please contact EXAIR for specific recommendations.

### **CALIBRATION OFFSET**

Occasionally, some users might use the ETC in a panel that has other temperature sensing equipment installed. If the temperature displayed on the ETC does not match the existing equipment, it can be offset to match. To do this, press and hold both arrow keys for (5) seconds. The display will show “CAL” for (5) seconds and then the Calibration Offset value. Use the arrow keys to adjust the value as needed ( $\pm 30^\circ$  max).

### **UNITS**

To change the units on the ETC, press and hold both arrow keys for (10) seconds. The display will show “F C” for 2 seconds, and then just the unit that the ETC is set to. Use the arrow keys to toggle to the desired unit of measurement. The new value will take effect (3) seconds after the last key stroke. The display will blink, then return to the primary display after (5) seconds.

### **SETTING THE THERMOSTAT**

Setting for the correct temperature is important. It is best to choose a temperature that keeps the electronics in the electrical enclosure functioning without setting the temperature so low that it simply wastes compressed air. For

**SETTING THE THERMOSTAT (Continued)**

most applications, a setting of 90 to 95°F (32 to 35°C) is sufficient. Most electronic components are normally rated at 104°F (40°C). Some newer electronics can withstand more heat and have a maximum temperature rating of 122°F (50°C). For these applications, a temperature setting of 104 to 111°F (40 to 44°C) is adequate. For best results, check the manual on the piece of equipment for the maximum temperature rating. To change the set point, push and hold the “Push to Set” button. Use the arrows to change the temperature accordingly. Release the “Push to Set” button when you are done.

**Note that the temperature you choose is the temperature the Cabinet Cooler will cool the enclosure down to.** The ETC has a built in hysteresis of about 4 degrees. For example, each ETC is pre-set to 93°F, so once the enclosure cools down to 93°F and the Cabinet Cooler shuts off, the ETC will allow the temperature to rise by 4 degrees to 97°F before turning the Cabinet Cooler back on. This will maintain an effective average of 95°F. If your desired maximum temperature is 95°F, then the ETC will need to be set to 91°F, etc.





**Maintenance, Inspection and Cleaning**

Periodically inspect the ETC unit, wiring and parts for damage. If any damage is observed, disconnect the power and contact EXAIR for repair or replacement parts.

Periodically clean the ETC with a soft cloth & mild detergent.

**EQUIPMENT ENVIRONMENTAL RATINGS**

Installation Category II (Transient Over-voltage)  
 Pollution Degree 2 (Temporary conductivity caused by condensation)  
 Altitude limit: 6,562 feet (2,000m)  
 ETC unit is intended for indoor & outdoor use  
 Humidity: 80% RH non-condensing  
 Mains supply voltage fluctuations  
 (±10% of nominal voltage)

Symbol	Publication	Description
	IEC 60417-5019	Protective Conductor Terminal (Safety Ground)
	IEC 60417-5007	On (Supply)
	IEC 60417-5008	Off (Supply)
	IEC 60417-5041	Caution, hot surface
	ISO 7000-0434	Caution, risk of danger

**WARRANTY**

There is a one year warranty against defects in workmanship and materials. Defective products must be returned freight prepaid for repair or replacement at our option. This warranty applies under conditions of normal use, but does not apply to defects that result from intentional damage, negligence or unreasonable use or exposure. The ETC has no user serviceable parts inside. Warranty is void if there is evidence of tampering.

If you have any questions or problems, please contact an EXAIR Application Engineer at:

Toll Free: 1-800-903-9247 (U.S. & Canada)  
 Telephone: 513 671-3322 outside of U.S. & Canada  
 Toll Free Fax: 866-329-3924 (U.S. & Canada)  
 FAX: 513 671-3363 outside of U.S. & Canada  
 E-mail: [techhelp@exair.com](mailto:techhelp@exair.com)  
 Website: [www.exair.com](http://www.exair.com)

For more information about this product, visit  
 "Frequently Asked Questions" at [www.exair.com](http://www.exair.com)  
**FAQ at [www.EXAIR.com](http://www.EXAIR.com)**